

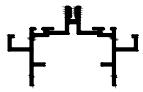

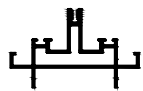



**OVERVIEW OF PROFILES**

DRAWING	CODE	WEIGHT (Kg/m)	DESCRIPTION	STATIC VALUE <small>Jx(cm4) / Jy (cm4)</small>
	12001	1.060	Horizontal profile	5.57 / 23.20
	12002	1.265	Vertical profile	6.59 / 22.69
	11201	0.368	pressure profile	0.07 / 2.96
	11204	0.552	pressure profile	1.29 / 5.85
	11206	0.276	Cover cap profile	0.15 / 3.36
	11207	0.342	Cover cap profile	0.71 / 4.77
	12206	0.368	Cover cap profile	0.13 / 7.72
	11231	0.220	Glass support	/
	11241	0.325	Single Toggle	/

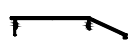

Profile Name	Profile Code	Weight (Kg/m)
Horizontal Profile	12001	1.060

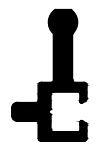
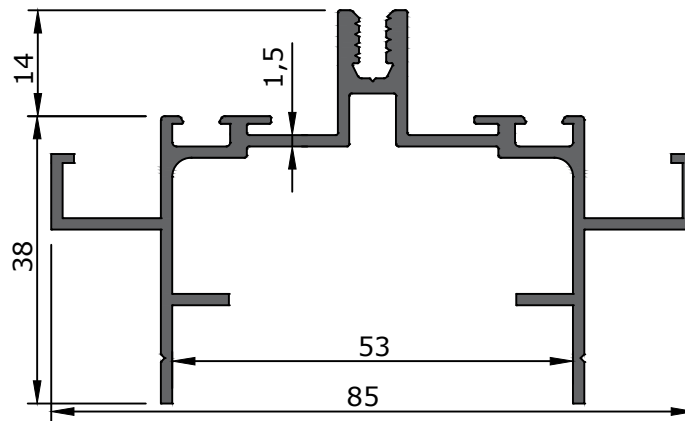
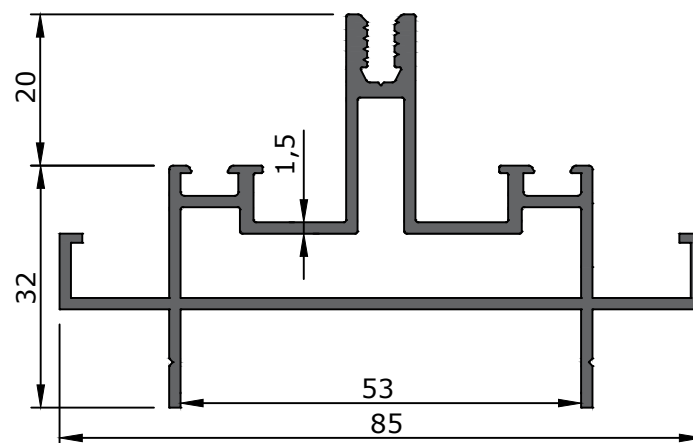

Profile Name	Profile Code	Weight (Kg/m)
Vertical Profile	12002	1.265

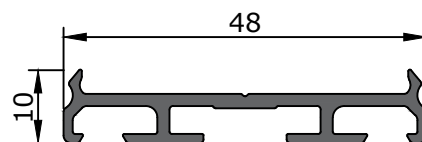

Profile Name	Profile Code	Weight (Kg/m)
Pressure Plate	11201	0.368

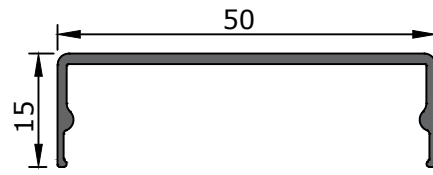
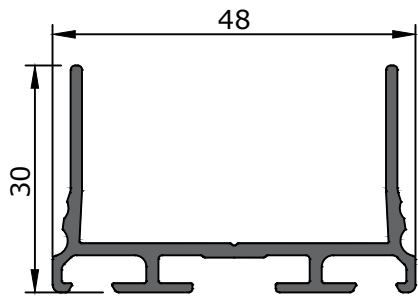

Profile Name	Profile Code	Weight (Kg/m)
Pressure Plate	11204	0.552

Profile Name	Profile Code	Weight (Kg/m)
Cover Cap Profile	11206	0.276

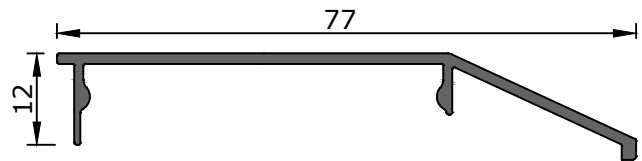
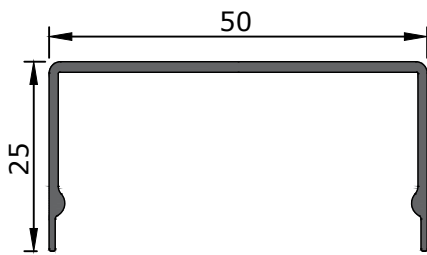

Profile Name	Profile Code	Weight (Kg/m)
Cover Cap Profile	11207	0.342



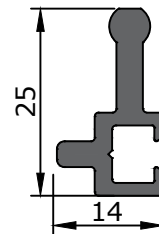
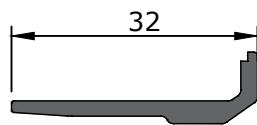



Profile Name	Profile Code	Weight (Kg/m)
Cover Cap Profile	12206	0.368

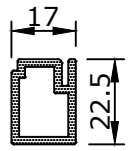
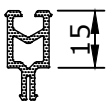
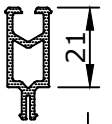
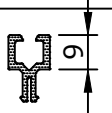
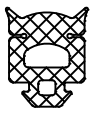

Profile Name	Profile Code	Weight (Kg/m)
Glass Support	11231	0.220

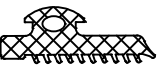
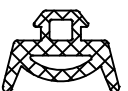
Profile Name	Profile Code	Weight (Kg/m)
Single Toggle	11241	0.325

**ACCESSORIES**

Drawing	Code	Description	Material
	P21	Support Block	PVC
	P01	Spacer Profile 15mm	PVC
	P02	Spacer Profile 21mm	PVC
	P15	Spacer Profile 9mm	PVC
	G 101	Glazing Gasket 9mm	EPDM
	G 104	Glazing Gasket 3mm	EPDM
	G 106	Glazing Gasket 3mm	EPDM
	G 107	Glazing Gasket 4mm	EPDM
	G 108	Interior Glazing Gasket 2mm	EPDM
	G 201	Interior Glazing Gasket 4mm	EPDM
	G 202	Interior Glazing Gasket 6mm	EPDM

**ACCESSORIES**

Drawing	Code	Description	Material
	G 203	Interior Glazing Gasket 8mm	EPDM
	G 114	Finishing Gasket	EPDM

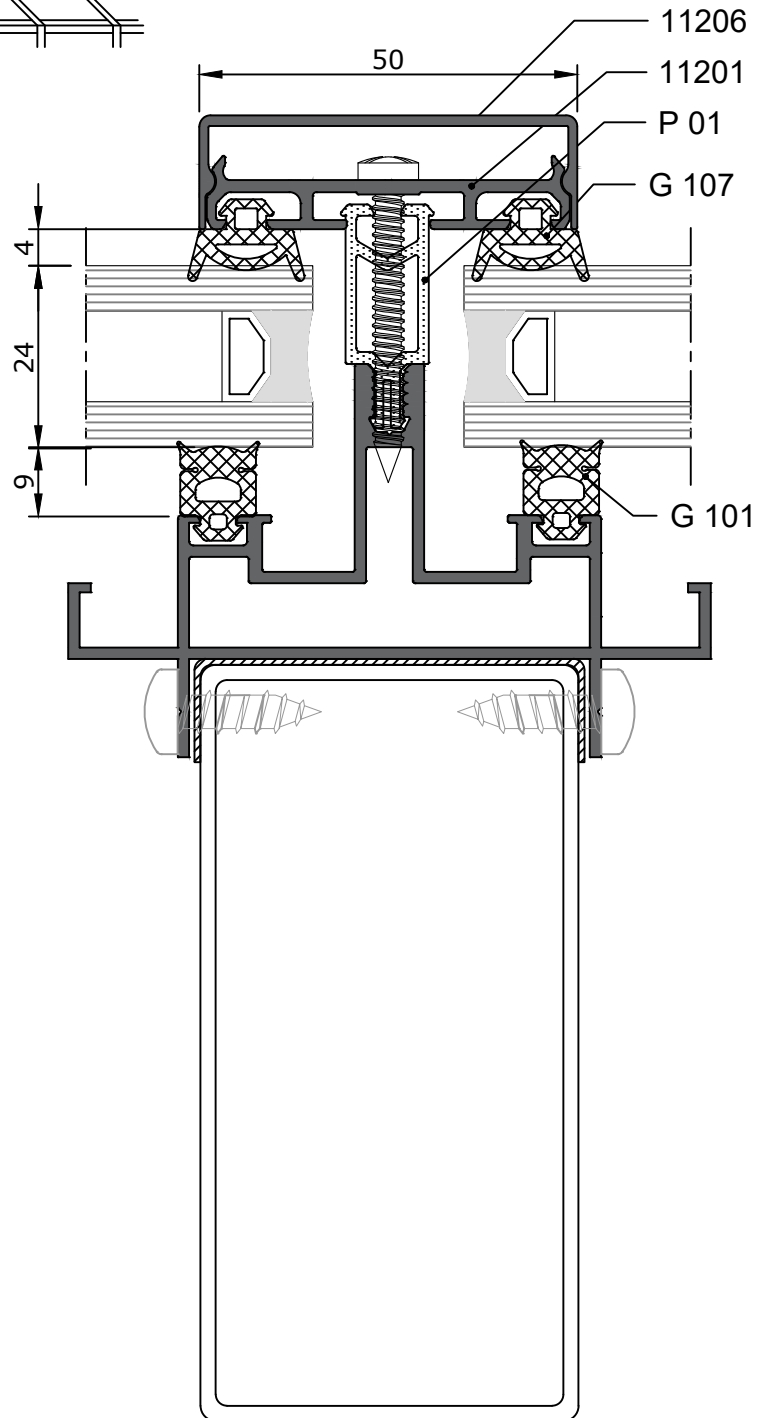
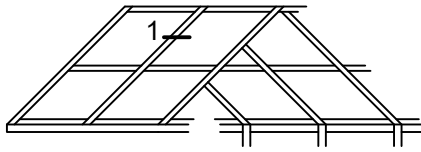

1

HATCH GUIDE : ● Aluminium    ● PolyAmid    ● PVC    ● EPDM    ● Sponge

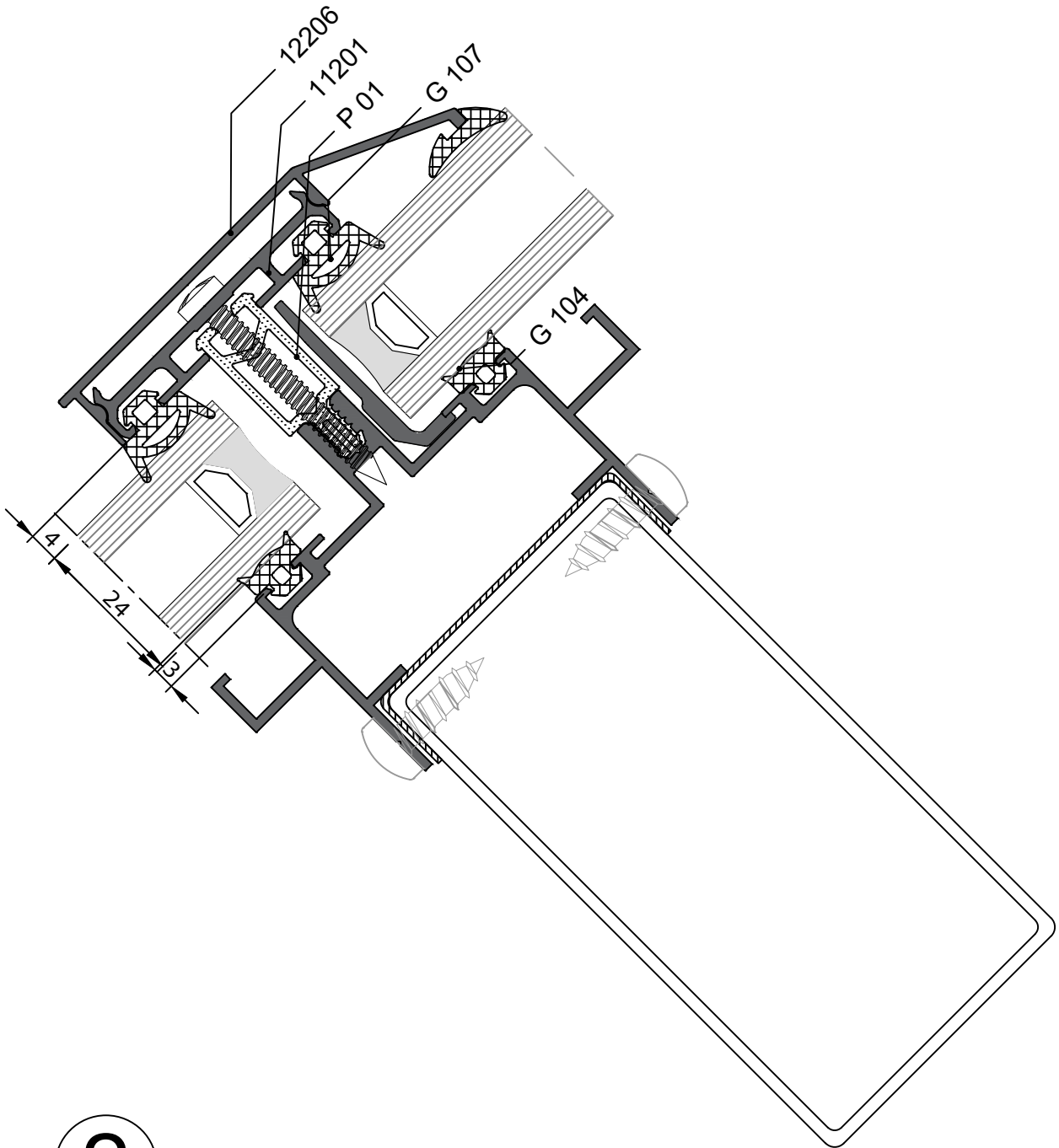
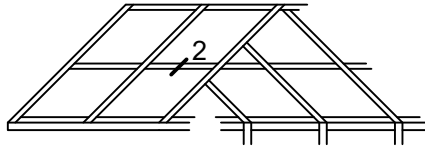

2

HATCH GUIDE : ● Aluminium    ● PolyAmid    ● PVC    ● EPDM    ● Sponge